

mi familia

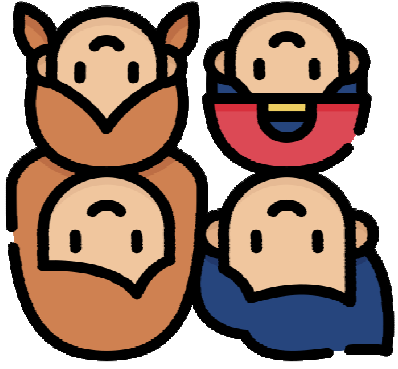

© Light Bulb Languages 2020 CS

Icons made by <https://www.flaticon.com/authors/freepik>

1

Hola, me llamo Félix.
Tengo ocho años.

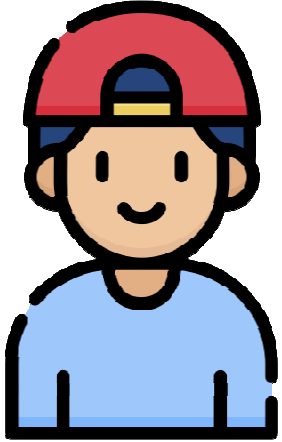

2

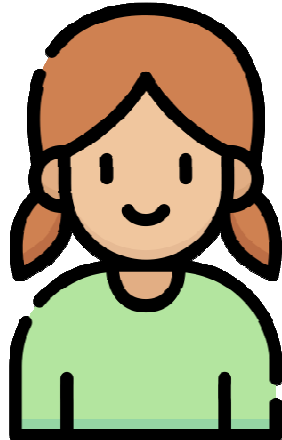

Mi hermana se llama Isabel.
Tiene seis años.

3



Mi padre se llama Gaspar,
y mi madre se llama Eva.

4

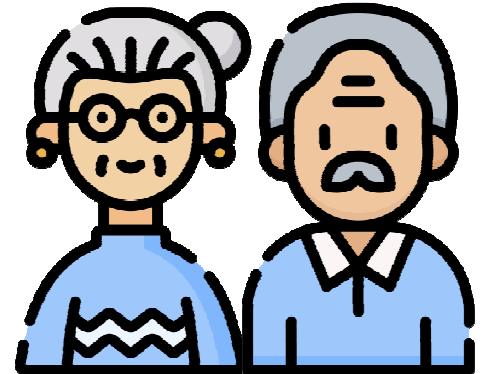

Mi abuelo se llama Gonzalo,
y mi abuela se llama María.

7

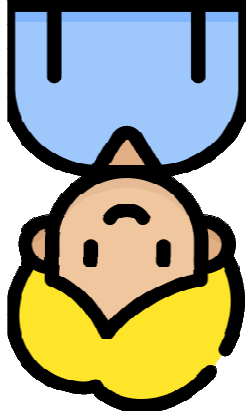

Mi mejor amigo se llama
Héctor. Tiene nueve años.

6

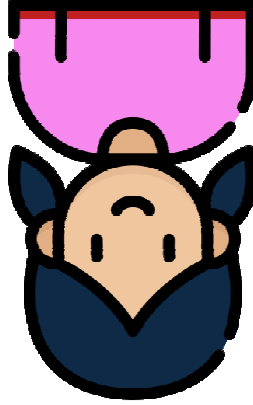

Mi prima se llama Raquel.
Tiene diez años.

5

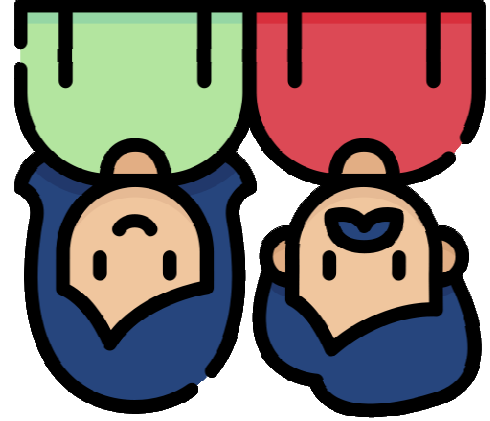

Mi tía se llama Alicia, y mi
tío se llama Nicolás.

How to fold the minibooks:

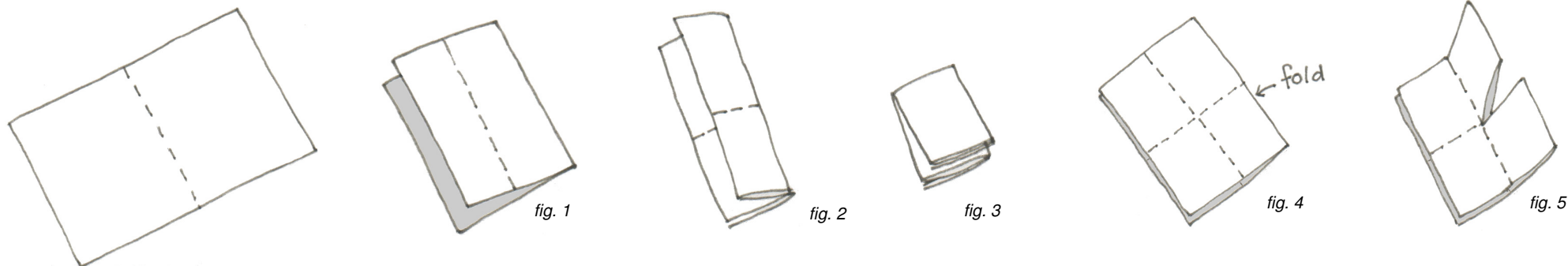

Fold the paper in half widthways. (*fig. 1*)

Keep the pre-printed side on the outside to make the folding easier later. The wrong side of the paper is shown grey in these illustrations.

Fold the paper in half again, in the same direction, to make a long bookmark shape. (*fig.2*)

Fold the paper in half once more, this time in the other direction. (*fig. 3*)

Unfold your last two folds. (*fig. 4*)

Cut or tear from the centre of the fold to where the two fold lines meet. (*fig. 5*)

Open out the piece of paper. It will be divided into 8 sections and will have a hole in the middle. (*fig. 6*)

Fold the paper in half again, lengthways this time, so that you have a row of 4 sections on each side. (*fig. 7*)

Hold one end in each hand and push your hands together (*fig. 8*) until the cross-section looks like fig. 9.

Find the cover of your minibook and fold the pages the right way. Your minibook is finished. (*fig. 10*)

